

İSİM:

TARİH:

ÇİZGİ ÇALIŞMASI

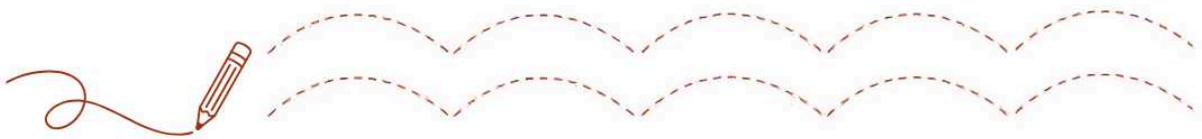
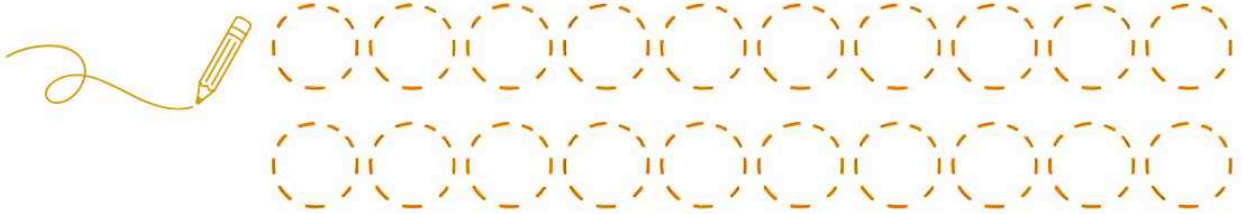
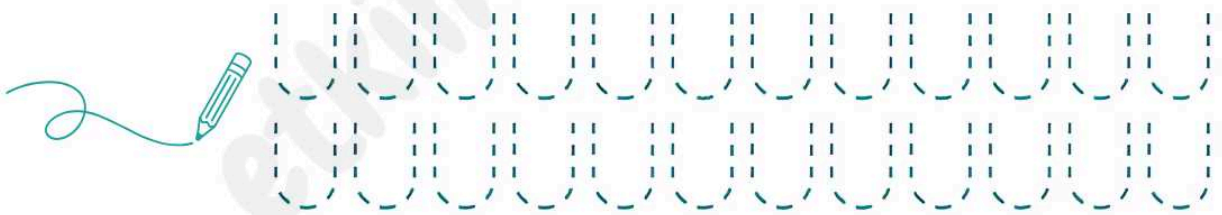
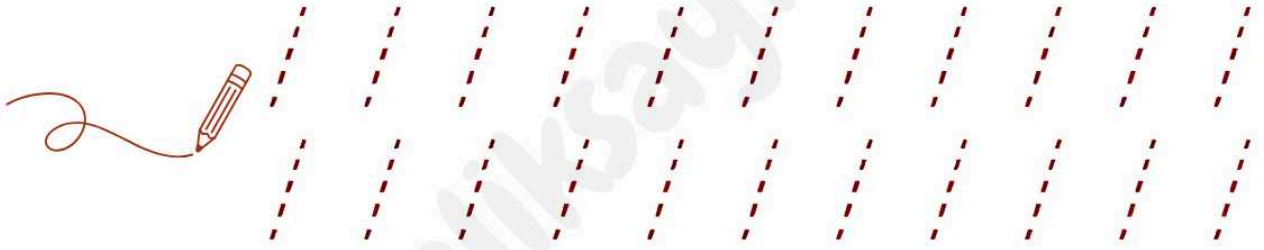
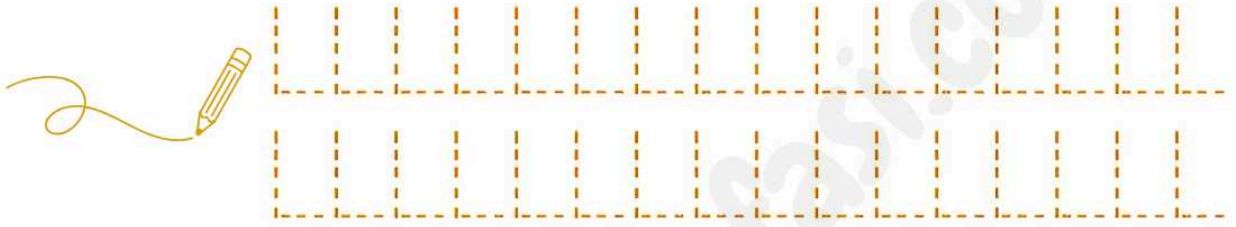
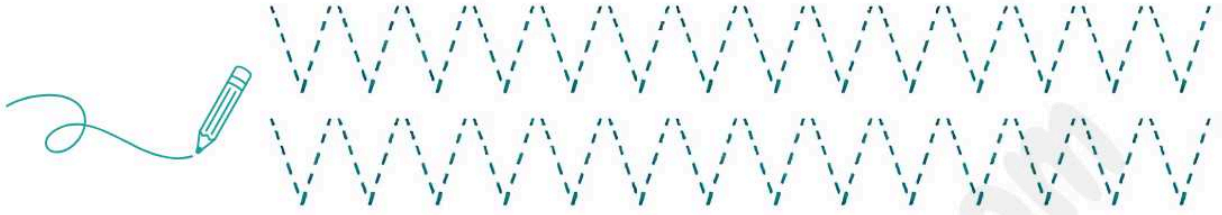

İSİM:

Tarih:

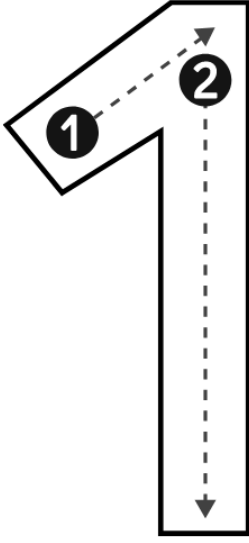

KAÇ TREN VAR? SAY VE BOYA.

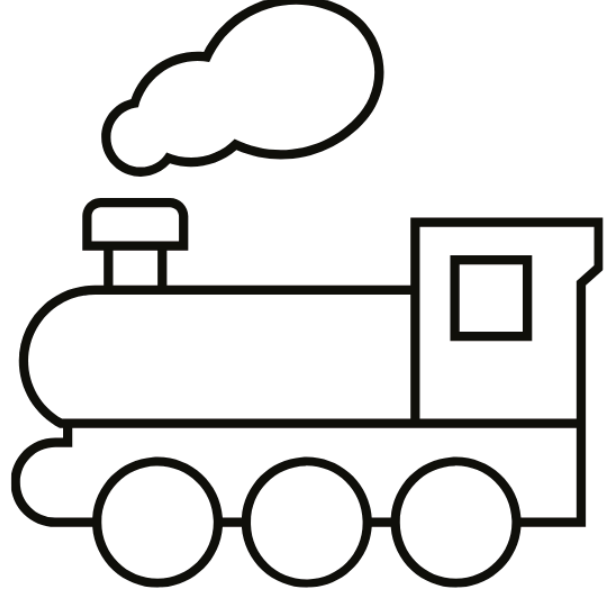

Çizgilerin üzerinden geçerek rakamları tamamla.

1 1 1 1 1

1 1 1 1 1

1 1 1 1 1

1 rakamını yaz.

1

İSİM:

Tarih:

Kaç KAPLUMBAĞA VAR? SAY VE

BOYA.

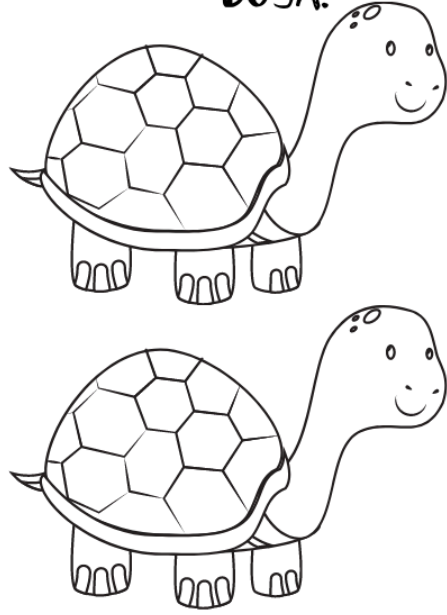
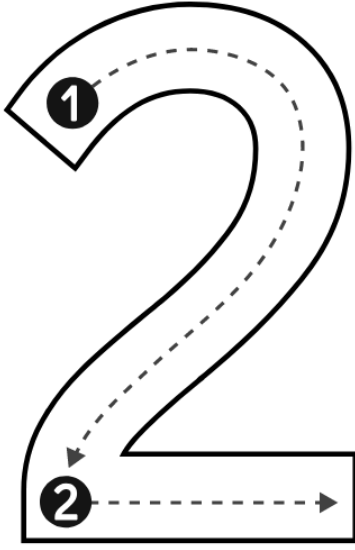

Çizgilerin üzerinden geçerek rakamları tamamla.

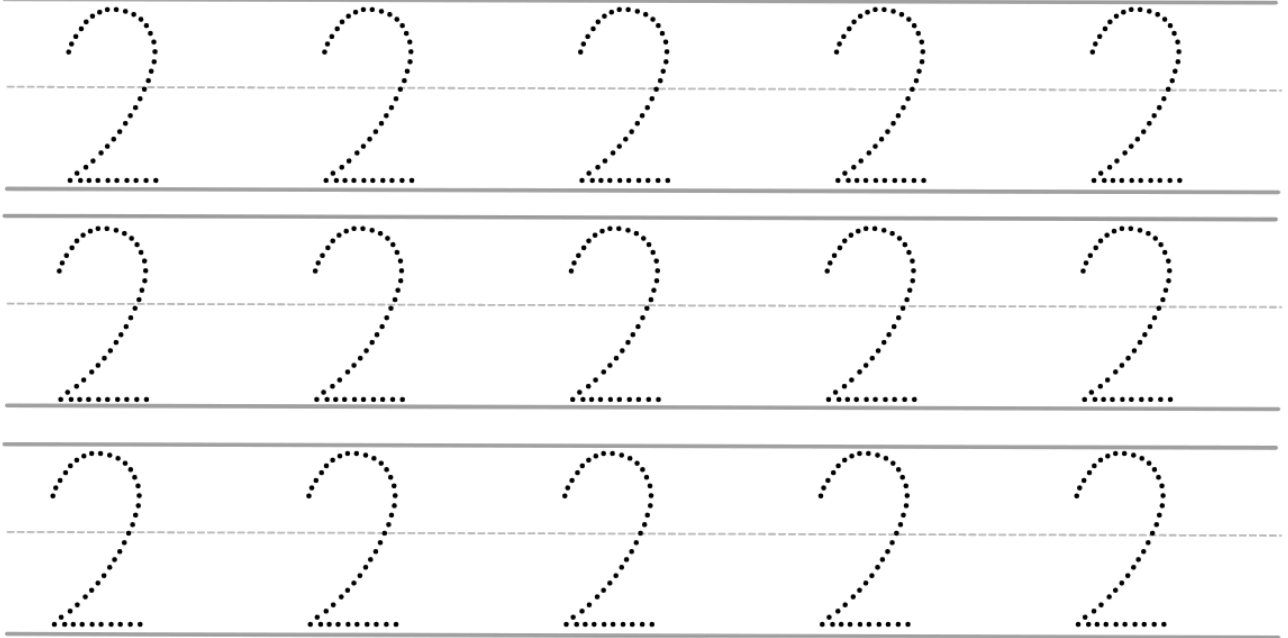

2 rakamını yaz.



İSİM:

Tarih:

Kaç araba var? Say ve boyala.

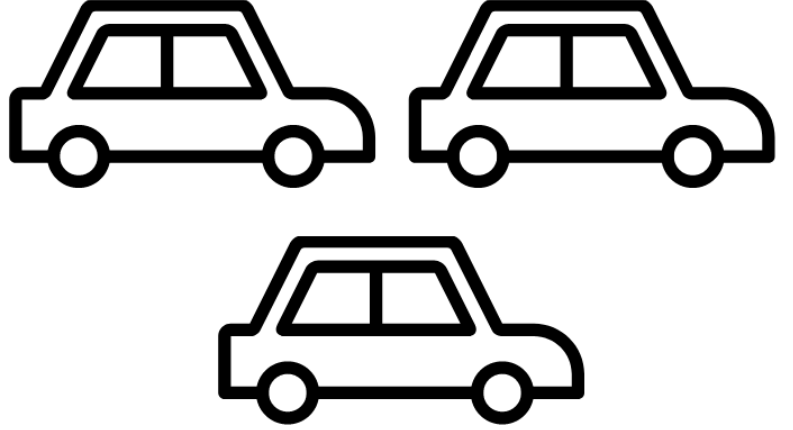
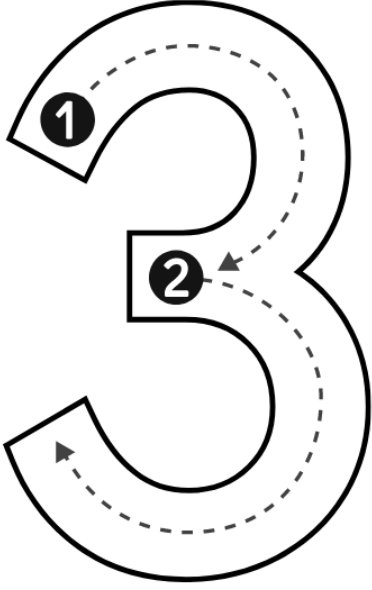

Çizgilerin üzerinden geçerek rakamları tamamla.

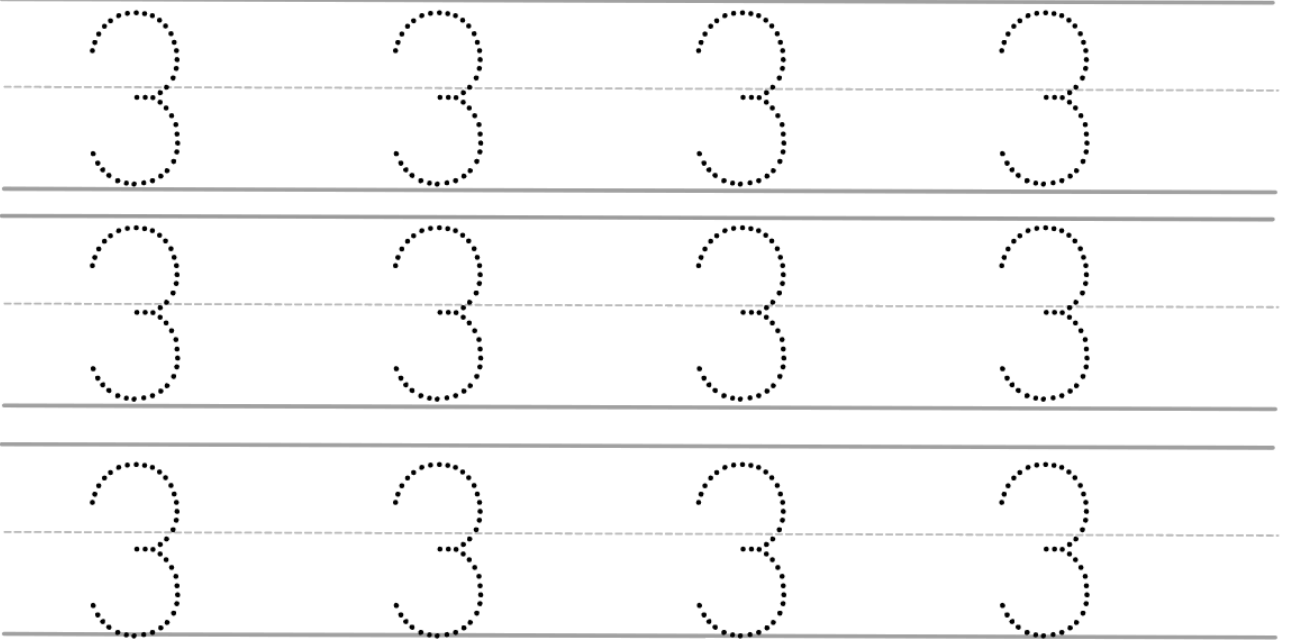

3 rakamını yaz.

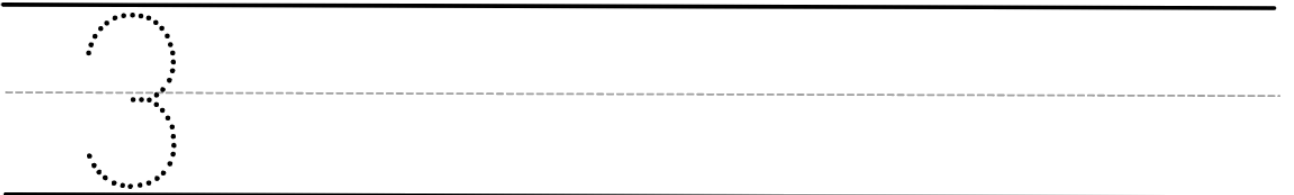

İSİM:

Tarih:

Kaç karınca var? Say ve

Boya.

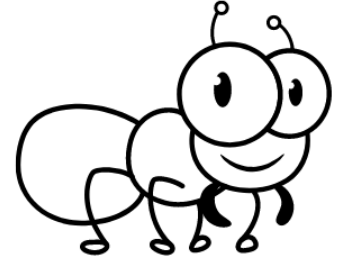
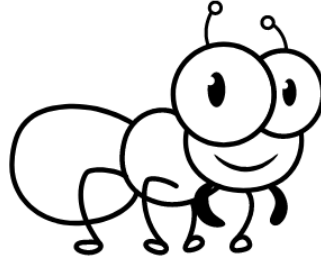
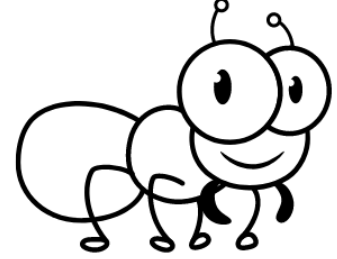
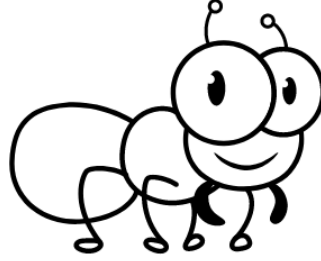
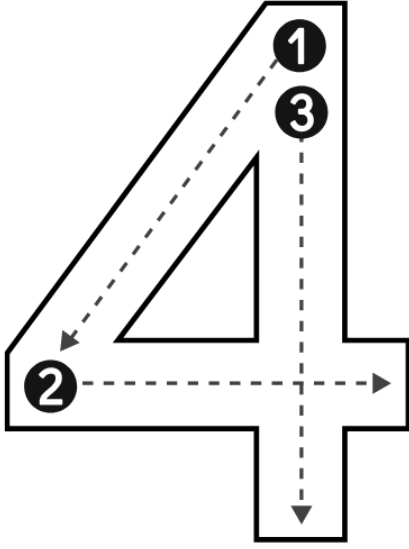

Çizgilerin üzerinden geçerek rakamları tamamla.



4 rakamını yaz.

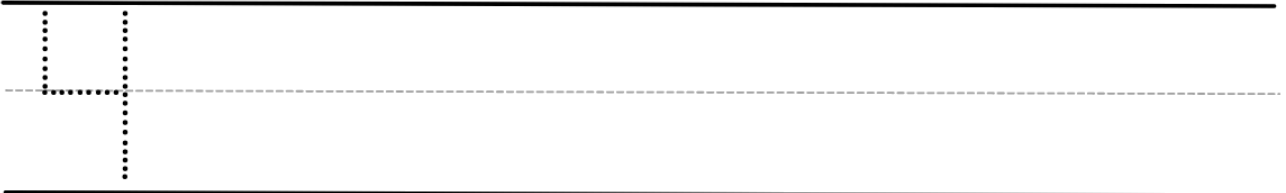

İSİM:

Tarih:

Kaç top var? Say ve Boya.

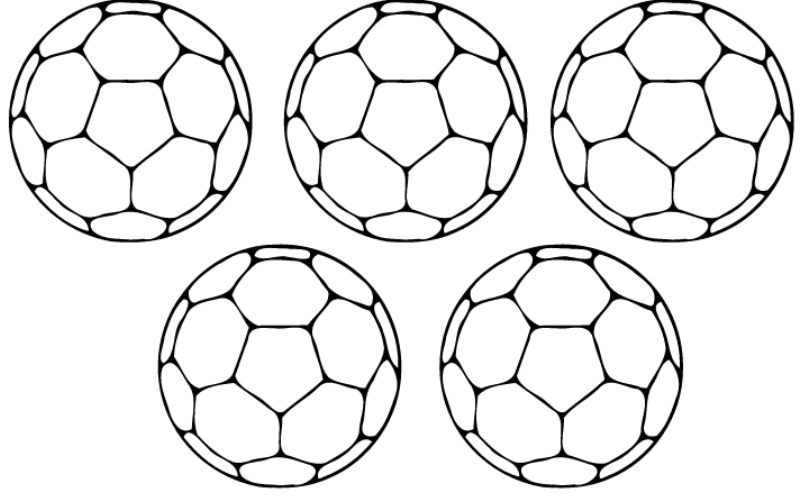
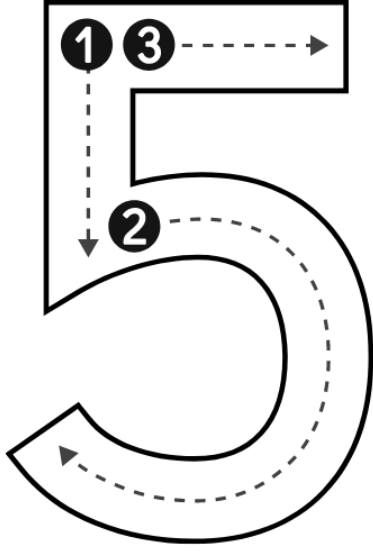

Çizgilerin üzerinden geçerek rakamları tamamla.

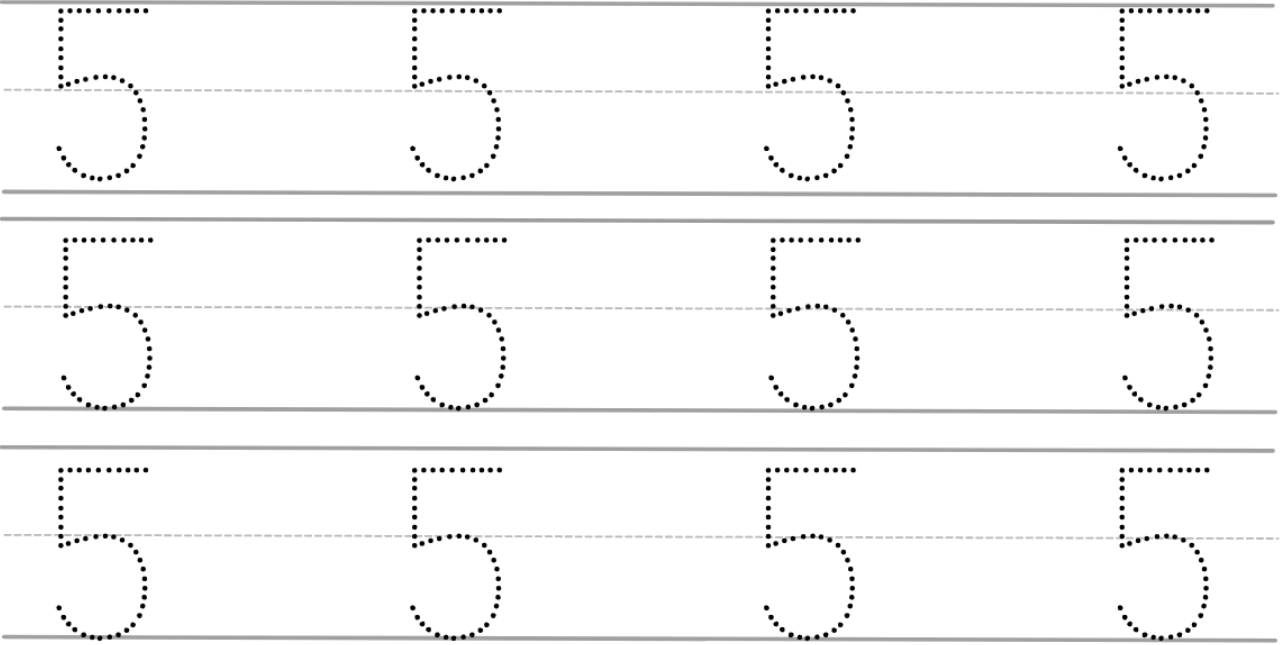

5 rakamını yaz.



**Rakamların üzerinden git ve son kutuya rakamı
kendin yaz.**

İsim:

Tarih:

1	1	1	1	
2	2	2	2	
3	3	3	3	
4	4	4	4	
5	5	5	5	

yapboz

Önce alttaki resimleri çizgili bölümlerden kes. Sonra sayıları doğru bir şekilde sıralayarak yapbozu tamamla.

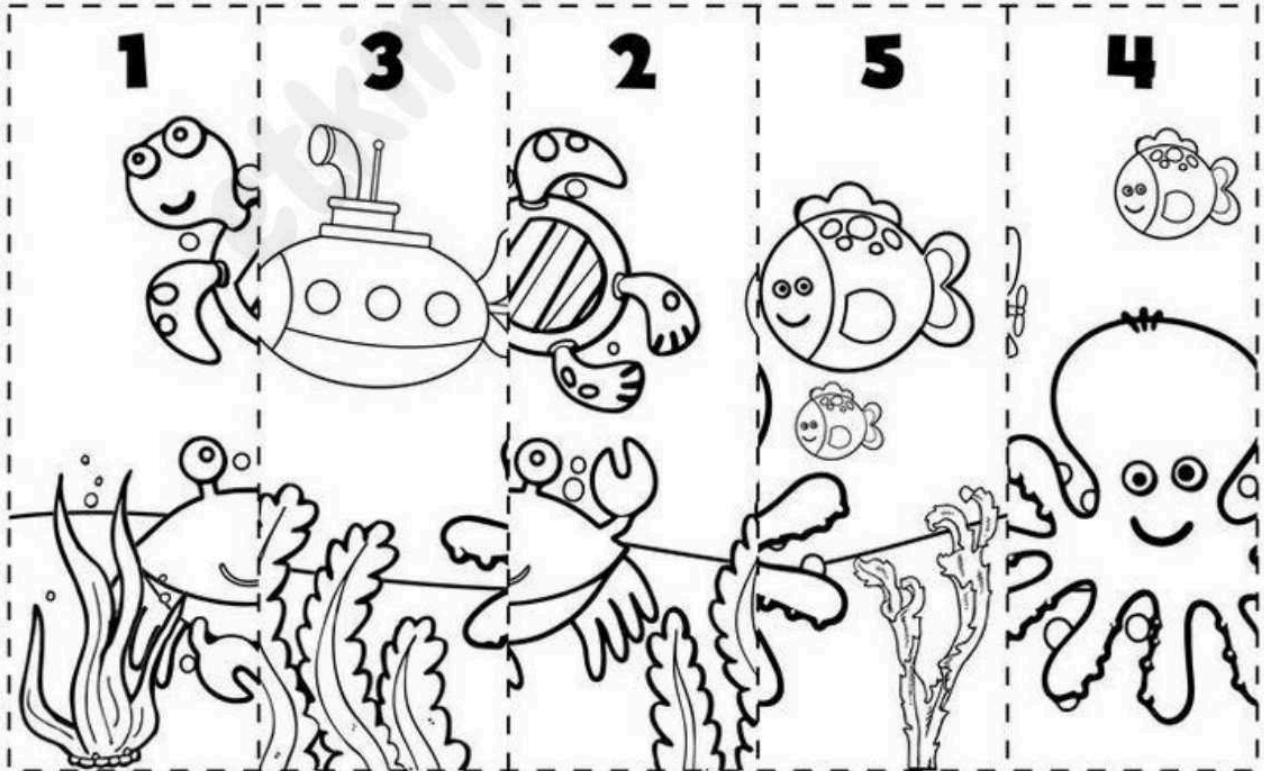
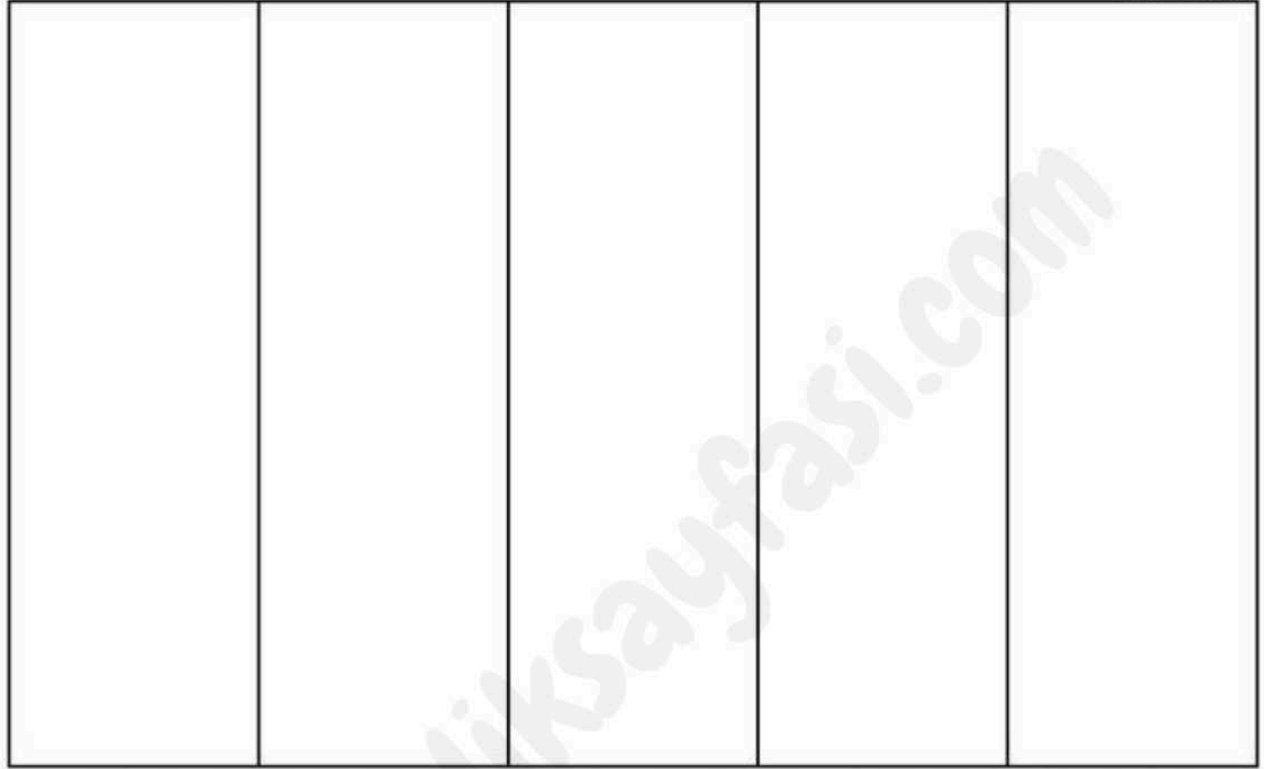

Nesneleri say ve doğru rakamı

boya

İsim:

Tarih:

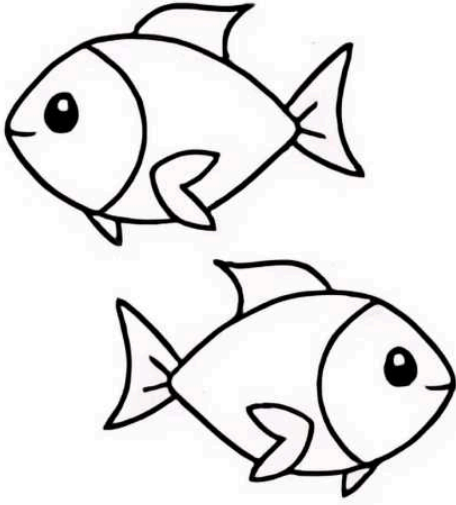

- 1
- 2
- 3

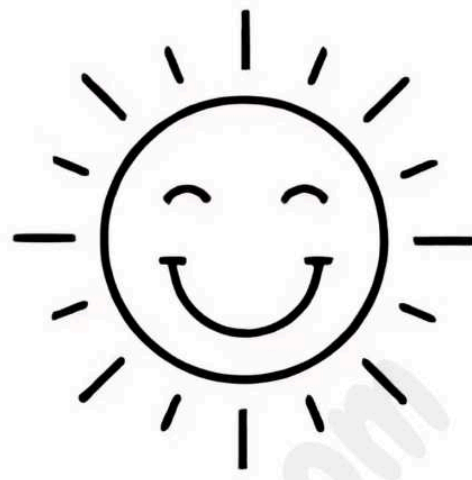

- 1
- 2
- 3



- 2
- 3
- 4

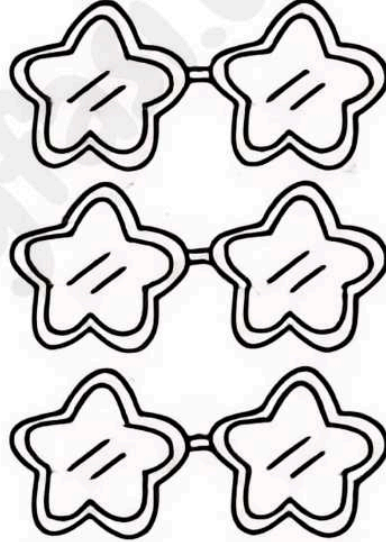

- 2
- 3
- 4

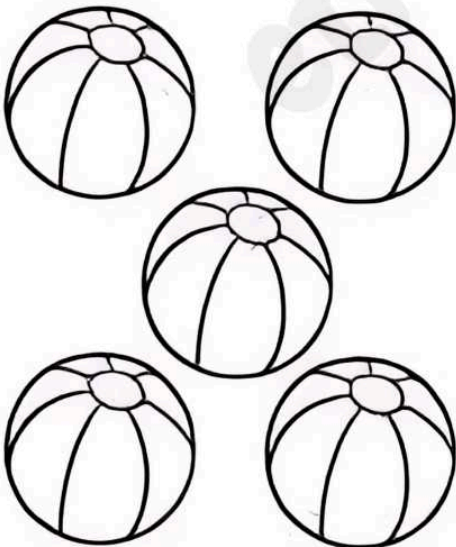

- 3
- 4
- 5

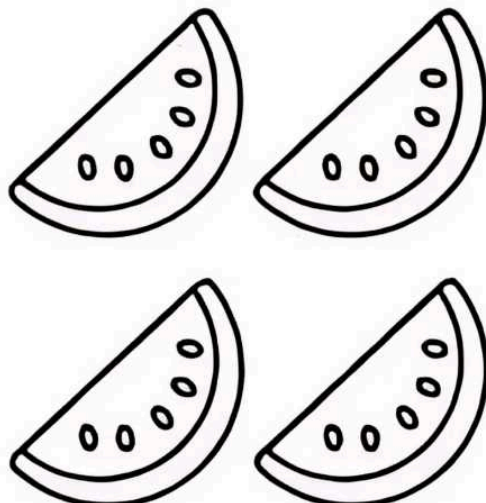

- 3
- 4
- 5

İSİM:

TARİH:

Renklerin üstüne gelmesi gereken rakamları yazarak çizgilerle sıralama yapalım.

1

2

3

4

5

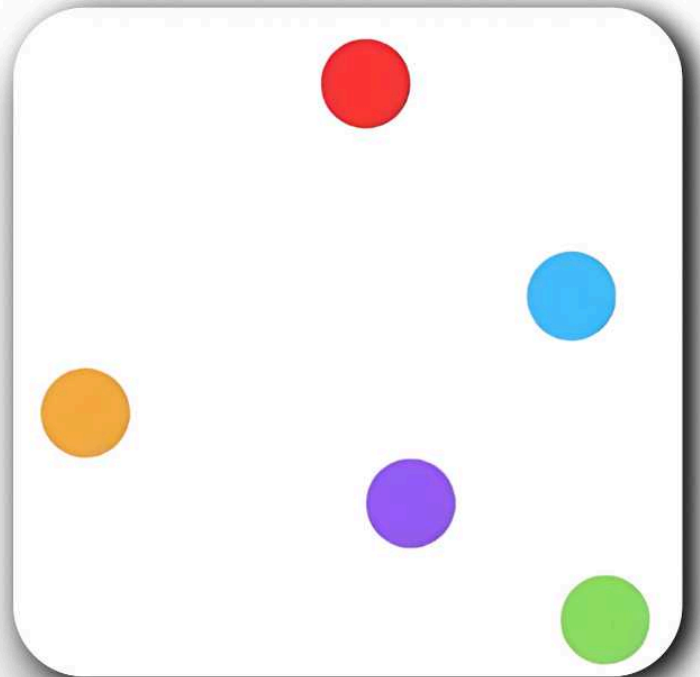
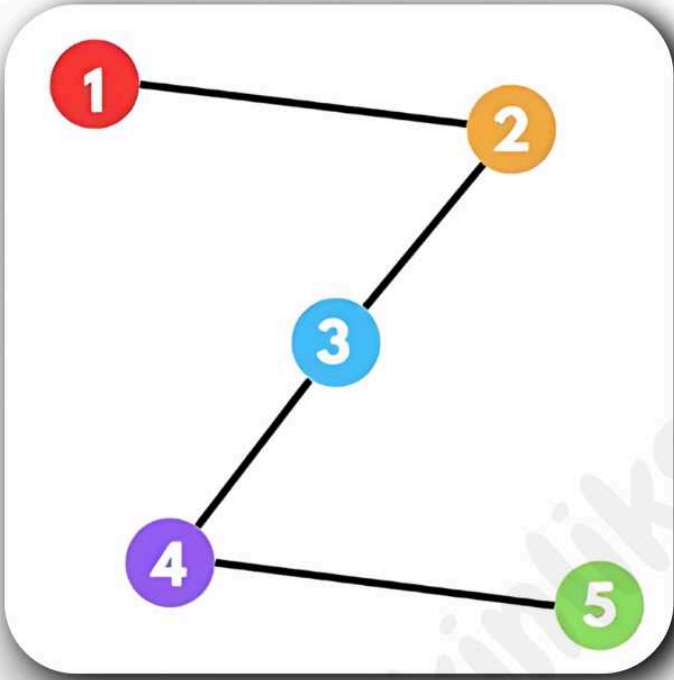

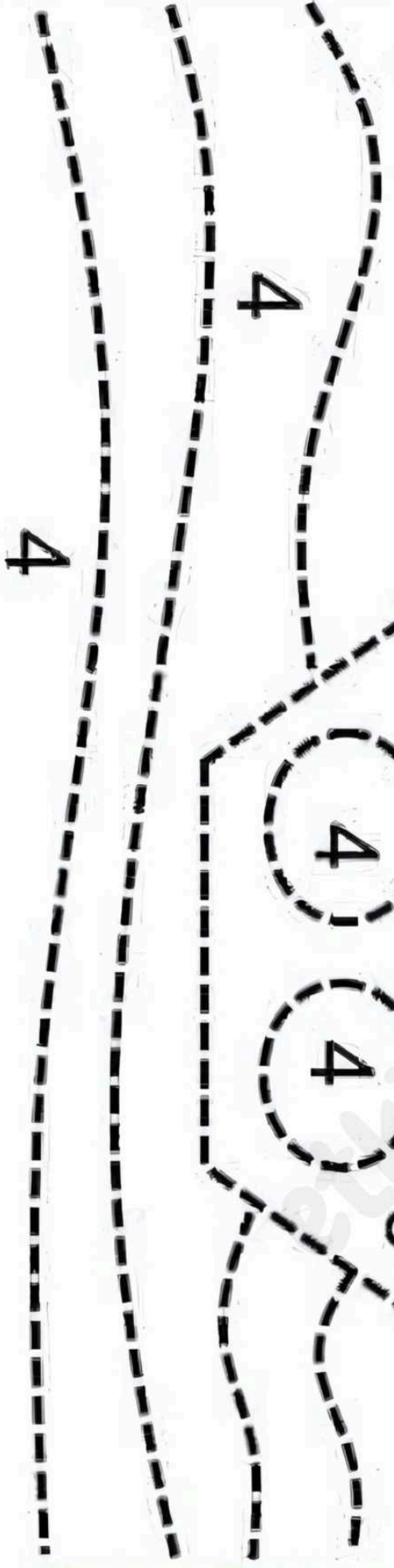
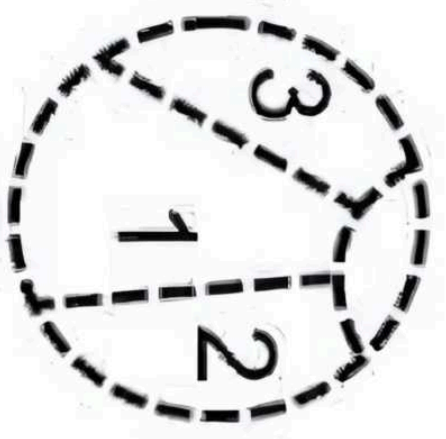
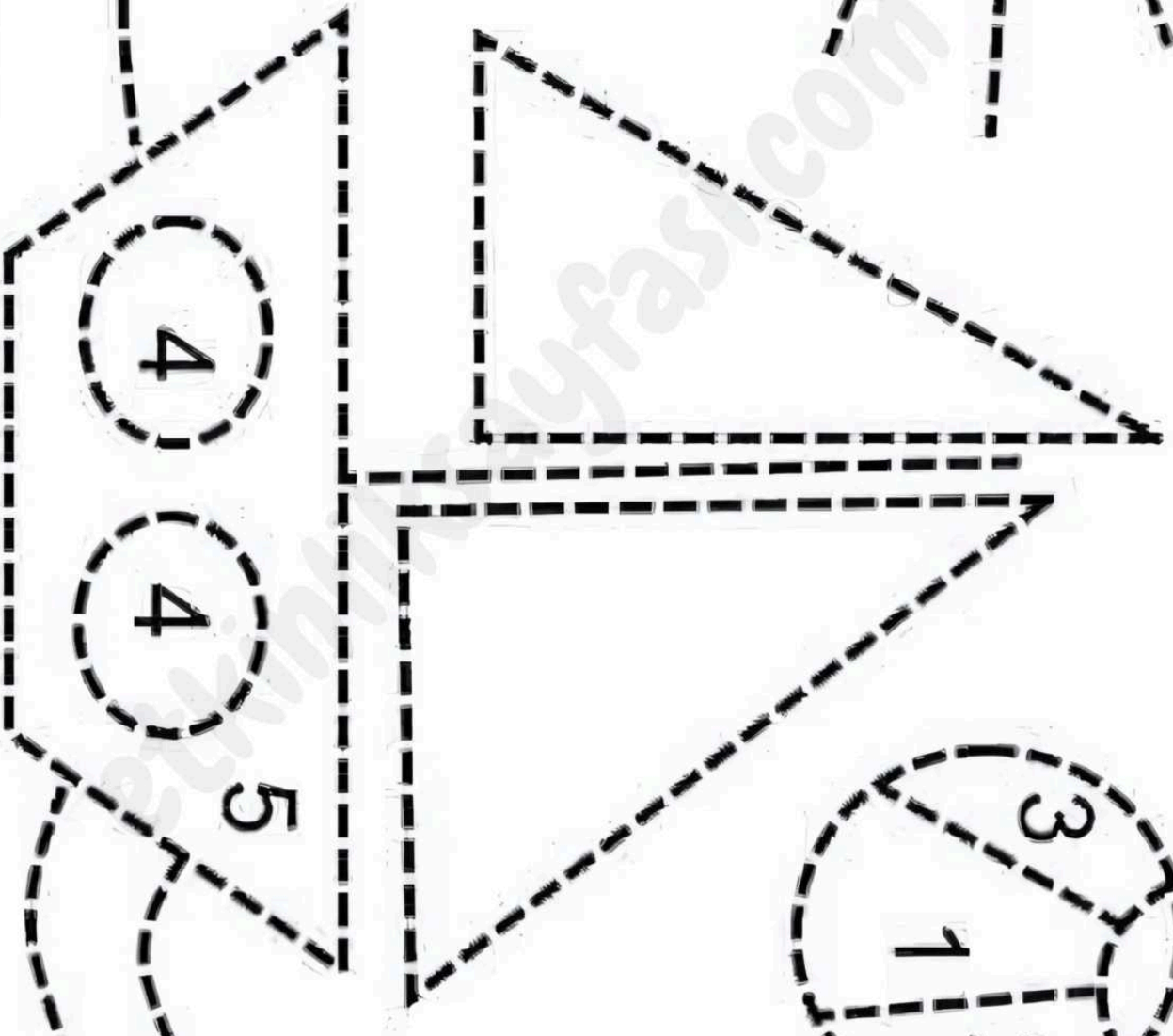
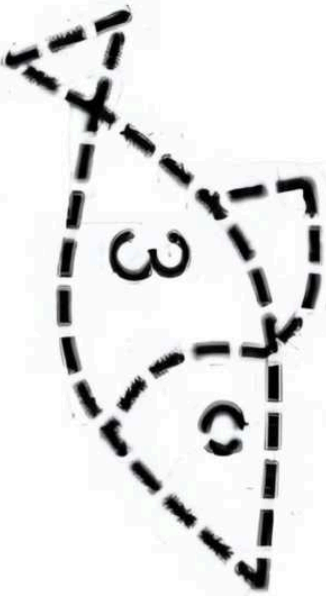
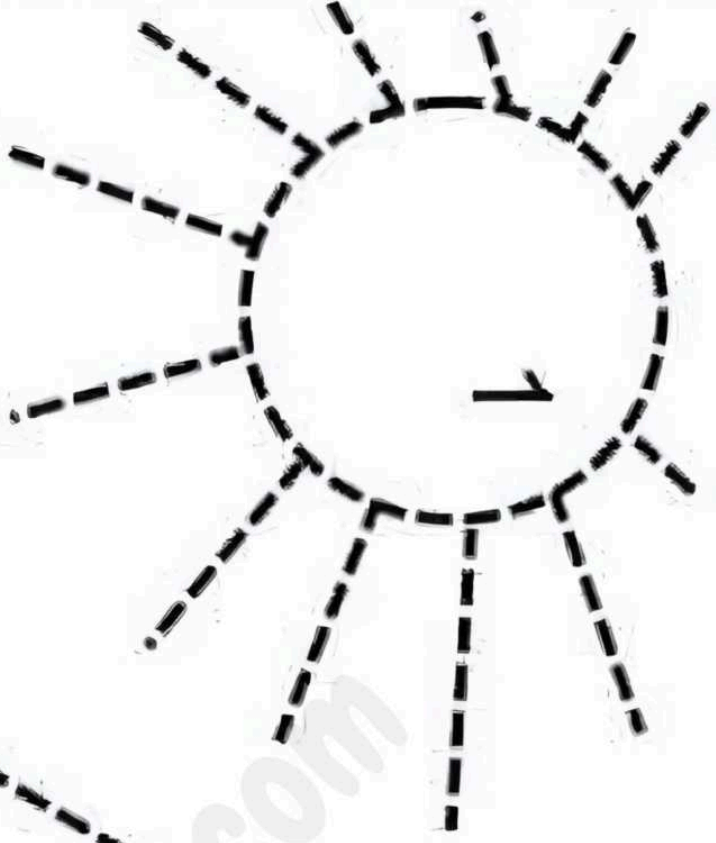

Üçgenleri **kırmızı**, daireleri **mavi**, kareleri **sarı** renkle boyayalım. Sonra çocukları kesip dil çubuklarına yapıştırarak şekil elbiseli çocuk kuklalarımızı yapalım.

